

# NS107S

## SPECIFICATION

The upgrade LED of RGB APA107

PWM refresh rate: +26kHz  
Oscillator Frequency: 30MHz

Document No.: SPC/ NS107S

Model No.: NS107S

Description: 5.5x5.0x1.6mm Top SMD Type 0.2Watt Power Integrated  
light source Intelligent control LED

Rev. No.: 01

# 正式规格书



## General Description

NS107S is a type ic for the three-color RGB Diming control strip and string ,This ic using the CMOS process to provide three-color RGB LED output driver to adjust the output with 256 gray scale and 32 brightness adjustment, NS107S with 2 signal output way , one is clock ,another is data, the clock and data is synchronized ,so that the crystal cascade piece of output movement is synchronized .

## Feature

- CMOS process, low voltage ,low consumption
- Synchronization of two-lane
- Choose positive output or negative RGB three-color LED output
- 8 bit(256 level) color set ,5bit(32 level) brightness adjustment
- Build-20ma constant current output
- With self-detection signal build in support for continuous oscillation PWM output ,can be maintained static screen

## Application

- LED lamp
- LED Strip ,led pixel module
- LED billboard LED screen

## PRODUCT SPECIFICATIONS

Color	MCD	Refresh rate	Voltage	Power Consumption	Weight (g)	Angle	Dimensions (mm) L*W*H	Operating Temperature
Full color	R:500-650mcd G:370-530mcd B:120-165mcd	400 cycle	DC5V	0.2W (MAX:1W)	1	160	5x5x1.4	-40-70℃

### PHYSICAL DIMENSIONS

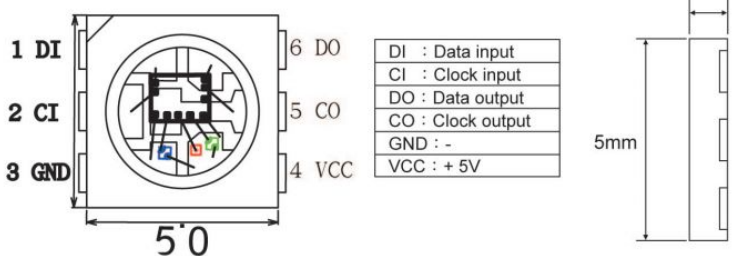
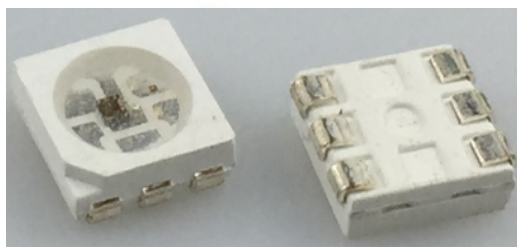

(PIN Description)

Item	Symbol	Pin Name	Function description
1	SDI	Data Input	control signal Input data
2	CKI	CLK Input	control signal Input Clock data
3	GND	Ground	The signal and power supply and grounding
4	VCC	Power	power supply pin
5	CKO	CLK Output	control signal output Clock data
6	SDO	Data Input	control signal output data

General Information

# NS107S

**NS107S** : The default is RGB chips with IC integration

Application Circuit

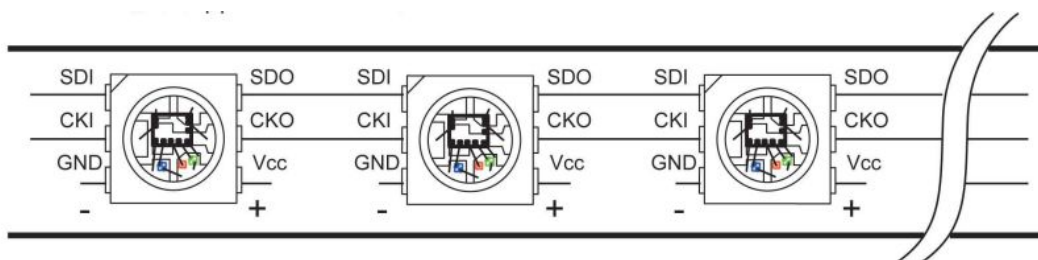

**(Block diagram)**

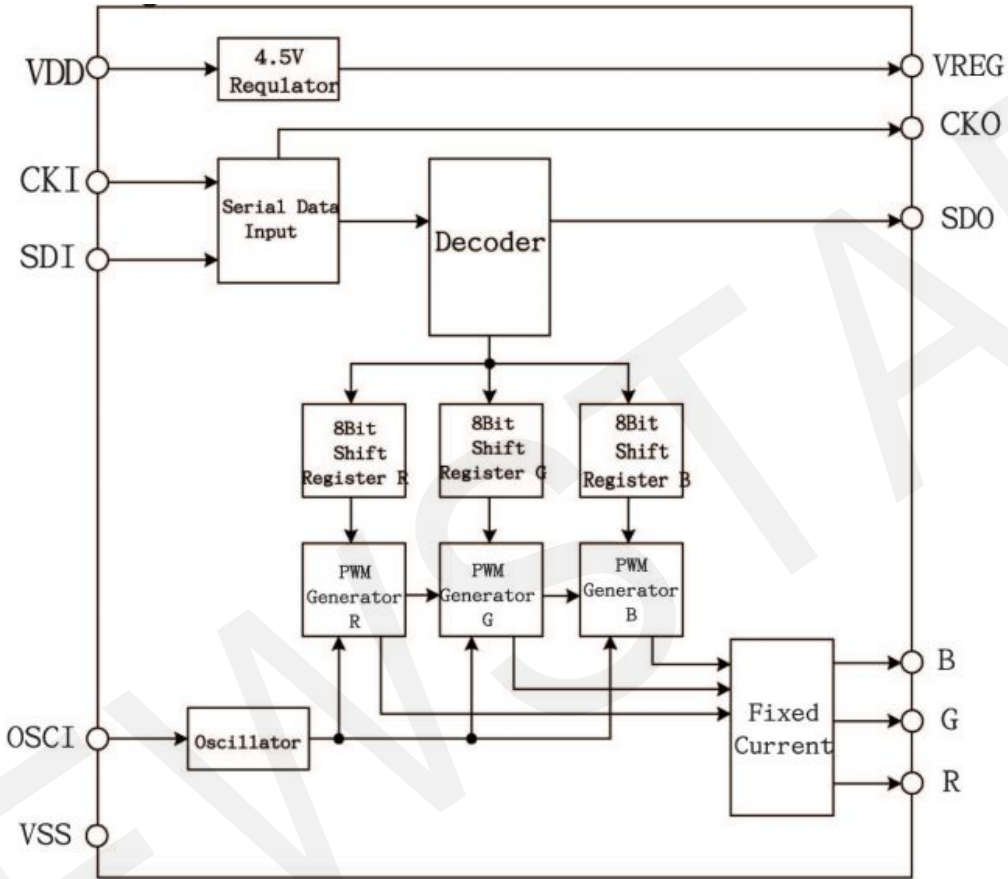

**(Absolute Maximum Rating)**

**Supply voltage** ----- **-0.3-6.0V**

**Input voltage**----- **VSS-0.3 to VDD +0.3V**

**Operating temperature**----- **-40 to +70°C**

**Storage temperature**----- **-50 to +125°C**

**Note:** Stress above those listed may cause permanent damage to the devices

7. Absolute Maximum Ratings (Ta=25°C, VSS=0V) :

Parameter	Symbol	Range	Unit
Power supply voltage	VDD	-0.5~+5.5	V
Logic input voltage	V <sub>IN</sub>	-0.3~VDD+0.3	V
Working temperature	Topt	-20~+80	°C
Storage temperature	Tstg	-50~+120	°C
ESD pressure	V <sub>ESD</sub>	4K	V

8. The electrical parameters (unless otherwise specified, TA=-20 ~ +70 °C, VDD=4.5 ~ 5.5V, VSS=0V):

Parmeter	Symbol	Min	Typical	Max	Unit	Test conditions
The chip supply voltage	VDD	---	5.0	5.3	V	---
R/G/B port pressure	VDS,MAX	---	---	17	V	---
The biggest LED output current	I <sub>max</sub>	---	---	20	mA	---
The clock high level width	TCLKH	---	---	>30	ns	---
The clock low level width	TCLKL	---	---	>30	ns	---
Data set up time	TSETUP	---	---	>10	ns	---
The frequency of PWM	FPWM	---	+26	---	KHZ	---
Static power consumption	IDD	---	1	---	mA	---
MAX Transfer Speed	OF	---	30	---	MHZ	---

9. Feature Descriptions:

(1) Series data structure

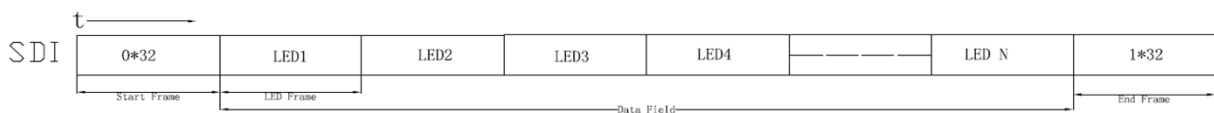

Start Frame 32 Bits

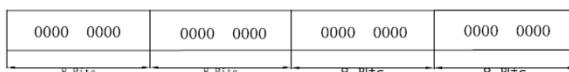

LED Frame 32 Bits

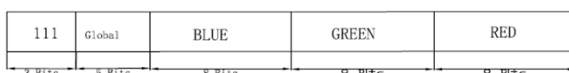

End Frame 32 Bits

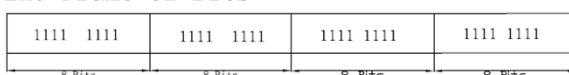

Global bit:5 bit (32 level) brightness setting,while controlling R,G,B three-color constant current output value,if set the global bit for the 10000( 16/31 ) is the output current is half again the original PWM settings

DATA MSB←→LSB	Driving Current
00000	0/31
00001	1/31
00010	2/31
.....	
11110	30/31
11111	31/31(max)

**PWM input and output signals Relations**

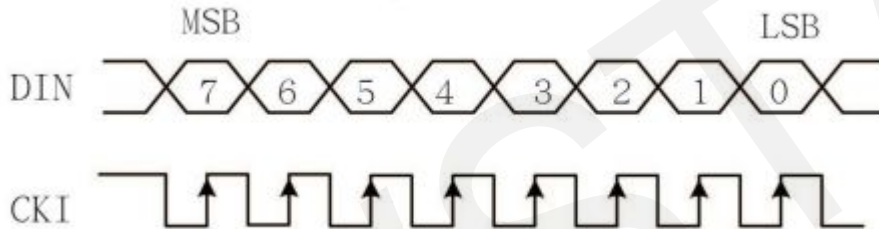

Data MSB--	Duty Cycle
00000000	0/256(min)
00000001	1/256
00000010	2/256
.....	
11111101	253/256
11111110	254/256
11111111	255/256(max)

(2). The number of pixel per second sent to the CKI frequency (FCKI) minus the Start Frame bit divided by the number 40 the number of LED Frame bit 32, if the CKI frequency(FCKI) to 512KHZ. The pixel number (512000-40)/32=15998, if the 50 second update Views can be connected in series LED number 15998/50=319. To increase the number of cascaded IC CKI frequency

(3).POLAR to empty ,R,G,B for the negative output;POLAR access VSS ,R,G,B is positive output

(4).VEN: self-detection

DATA field to the middle of 3 bit is B,G,R in the MSB of the opposite phase,otherwise regarded as invalid data. VEN close to the empty when the self-detection; when VEN VSS then activated self-detection

(5).CSEL to empty when the CKO and CKI,RP:CSEL connected with VSS when the CKO compared with CKI.

12. Packaging Standard:

**NS107S RGB**

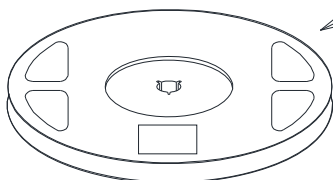
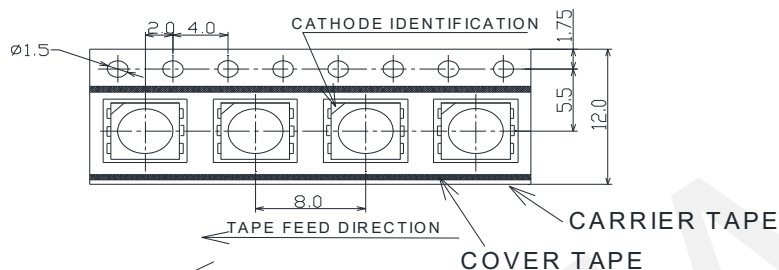

REEL (178x12mm)  
 (INNER 1000pcs LED MAX)

ESD POLYETHYLENE BAG

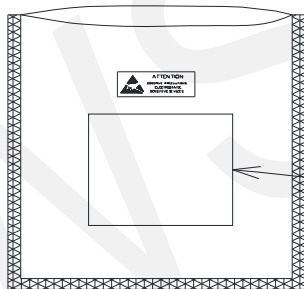

<p><b>NEWSTAR</b>  <b>SMD</b>                  PRODUCT NO.: NS107S                  QUANTITY.: 1000 PCS                  Lot No.: NST2018030302-11                  DATE: 2018-03-03</p> 
--

LABEL SKETCHING

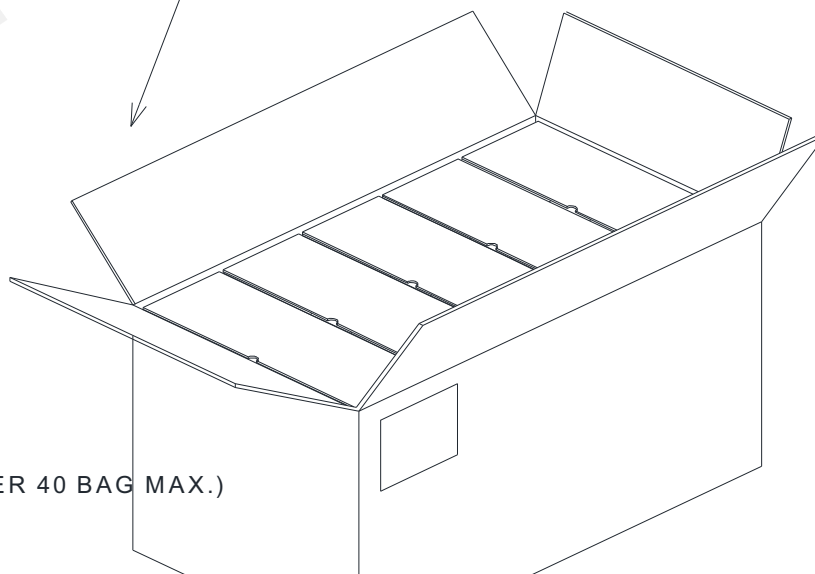

CARDBOARD (INNER 40 BAG MAX.)

The reel pack is applied in SMD LED. The LEDs are packed in cardboard boxes after packaging in normal or anti-electrostatic bags. cardboard boxes will be used to protect the LEDs from mechanical shocks during transportation. The boxes are not water resistant and therefore must be kept away from water and moisture.

## TOP SMD LED Application Notes

### NS107S RGB

#### 1. Features

The Purposes of making NEWSTAR's customers and users to have a clear understanding on the ways how to use the LED.

#### 2. Description

Generally, The LED can be used the same way as other general purposed semiconductors. When using NEWSTAR's TOP SMD LED, the following precautions must be taken to protect the LED.

#### 3. Cautions

##### 3.1. Dust & Cleaning

This emitter has a silicone surface, There are many benefits to the silicone surface in terms of optical properties and improved reliability. However, silicone is a softer material and prone to attract dust. While a minimal amount of dust and debris on the LED will not cause significant reduction in illumination, steps should be taken to keep the emitter free of dust.

These include keeping the LEDs in the manufacturer's package prior to assembly and storing assemblies in an enclosed area after installing the emitters.

Surface condition of this device may change when organic solvents such as trichloroethylene or acetone were applied.

Avoid using organic solvent, it is recommended that isopropyl be used as a solvent for cleaning the LEDs. When using other solvents, it should be confirmed beforehand whether the solvents will dissolve the package and the resin or not.

Do not clean the LEDs by the ultrasonic. When it is absolutely necessary, the influence as ultrasonic cleaning on the LEDs depends on factors such as ultrasonic power. Baking time and assembled condition. Before cleaning, a pre-test should be done to confirm whether any damage to the LEDs will occur.

##### 3.2. Moisture Proof Package

In order to avoid the absorption of moisture during transportation and storage, LED are packed in the aluminum envelop, A desiccant is included in the aluminum envelop as it absorbs moisture. When moisture is absorbed into the AMT package it may vaporize and expand during soldering. There is a possibility that this can cause exfoliation of the contacts and damage to the optical characteristics of the LEDs. For this reason, the moisture proof package is used to keep moisture to a minimum in the package.

##### 3.3. Storage

In order to avoid the absorption of moisture, It is recommended to store SMD LED (in bulk or taped) in the dry box (or the desiccator ) with a desiccant, Otherwise to store them in the following environment as recommended.

a. Temperature: 5°C~30°C

b. Humidity: 60% RH Max

It is recommended to solder the LED as soon as possible after unpacking the aluminum envelop, But in case that the LED have to be left unused after unpacking envelop again is requested.

The LED should be soldering within 1 hours after opening the package.

If baking is required, A baking treatment should be performed as follows:

70°C±5°C for more than 24 hours.



